

WIDE DOOR-TYPE DISHWASHER

PDX PDX-1001JD

POWERFUL
& EFFICIENT

PDX-1001JD is designed to wash large-sized dishware including pots and pans. It has larger dishwasher rack with taller door opening inlet height. This model is recommended for catering capacity of 300 people.



CE

PRODUCT ADVANTAGES

■ Increased Size and Washing Capacity :

PDX-1001JD series are 30% larger than regular door-type. Larger dishwasher rack and increased inlet opening height allows to wash more at once as well as larger size dishware.

■ High Pressure Wash Pump :

Wide door-type dishwasher uses high pressure wash pump. It also uses high quality energy efficient rinse pump for excellent rinse results and maximum overall hygiene.

■ Large Round Window :

Wash and rinse cycles are observable through the large tempered glass window for ensuring dishware hygiene and proper machine operation.

■ 3 Heating Elements (Heaters) :

2 heaters are installed in the wash tank and 1 heater in the rinse tank. This design shortens the overall heating time and allows consecutive wash above 70°C. It also lets the machine momentarily operate even one of the heaters are damaged.

■ Imported Machine Parts :

Essential machine parts are imported from South Korea to ensure high quality machine performance and durability.

MODEL	PDX-1001JD
TOTAL RATED LOAD	12kW / 15kW
ELECTRICAL SPECS	380V, 50Hz
CAPACITY (RACKS)	50 / hr
INLET HEIGHT	480 mm
RINSE CONSUMPTION	6 L / m
WASH TANK SIZE	68 L
RINSE TANK SIZE	38 L
HEATER CAPACITY	6.0kW, 3.5kW, 2.1kW
WASH PUMP LOAD	0.75kW
DIMENSION (OUTER)	780 x 890 x 1410 mm
NET WEIGHT	120 KG

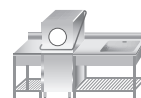

Straight-through (R → L)

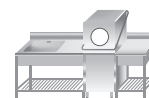

Straight-through (L → R)

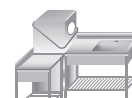

Left Corner (R → L)

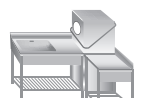

Right Corner (L → R)

PRODUCT DETAILS



PDX-1001A/B/C
Door-Type

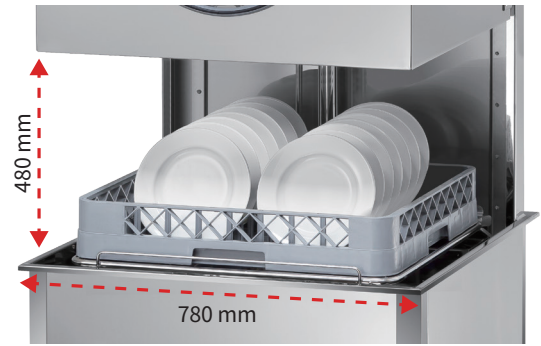

PDX-1001JD
Wide Door-Type

Many times we face difficulties with washing large amount of dishwares in limited kitchen space; especially, kitchens that do not have enough space to install a rack conveyor-type dishwasher or door-type dishwasher is simply too small to do all the work. Also, washing large pots and pans by hand requires extra work and longer period of time.

PDX-1001JD is a wide door-type dishwasher that has 30% increased size compared to regular single door-type dishwashers. It also has 90mm taller door inlet opening height and uses 600 x 600 mm customized stainless dishwasher rack for stacking more dishwares. This model is able to meet the all the customer needs above.

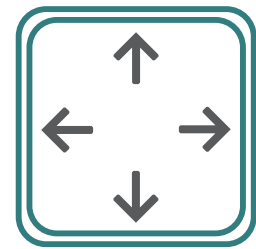

Customized Rack
600 x 600 mm

MODEL COMPARISON CHART

Type	Model & Dimension	Electric Spec	Rack Size	Inlet Height	Tank Size
Door	PDX-1001A/B/C	220V (5/7kW)	500 x 500 mm	390 mm	Wash Tank : 42L
	680 x 780 x 1355 mm	380V (5~12kW)	(International)		Rinse Tank : 28L
Wide Door	PDX-1001JD	380V (12/15kW)	600 x 600 mm	480 mm	Wash Tank : 68L
	780 x 890 x 1410 mm		(Customized)		Rinse Tank : 38L

DIMENSIONS

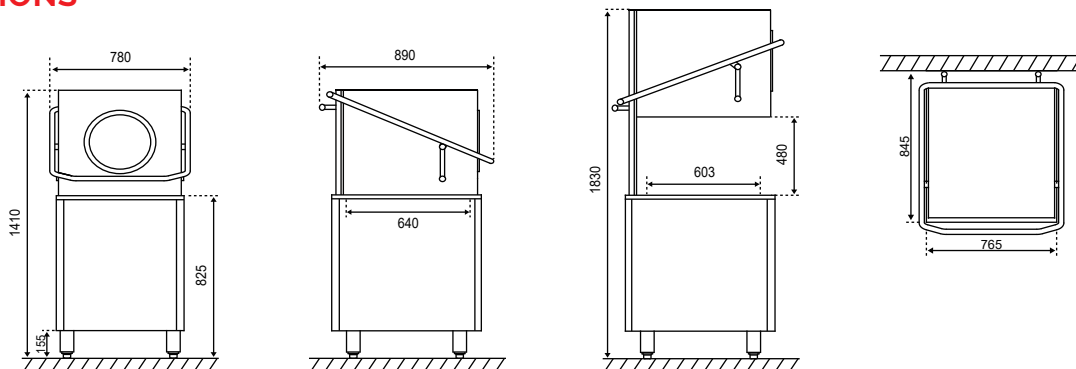

Door foot height extends from 155mm to 185 mm. Please adjust the foot height when installing with sink and work tables.

